

FIJACION PARED
WALL FIXATION

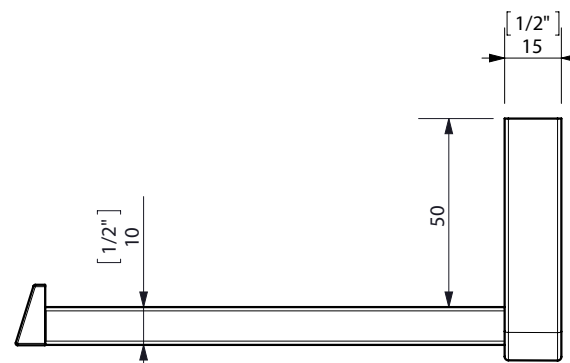
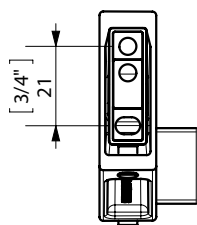

espec_550

Peso / Weight / Poids : 0,300 Kg.

Data / Datos / Données:

Normas / Regulations / Normes UNE 67100, UNE-EN-ISO 9227:2012, EN-ISO 10289:2001

Imágenes no a escala / Draw not to scale / Echelle non respectée

Sonia S.A se reserva el derecho de realizar cualquier cambio sin previo aviso
Sonia S.A has the right to make changes without notice
Sonia S.A se réserve le droit de procéder à tout changement sans notification préalable



www.sonia-sa.com